

inpro[®]

• **IPC**[®]

Door + Wall Protection Systems

Uniclass L4423			
Cl/SfB			
(42)	X	(J4)	

inpro[®]

INTERIOR AND EXTERIOR
ARCHITECTURAL PRODUCTS

Available in the UK exclusively through:



Intastop Ltd, Holly Street, Kelham Street, Industrial Estate, Doncaster, DN1 3TR
Tel: +44 (0)1302 364 666, Fax: 01302 364 777, Email: sales@intastop.com

www.intastop.com

©2017 Inpro[®] Corporation



Exclusive UK distributor visit intastop.com

Obsessively protecting your buildings and the people who use them.[™]

Your building says a lot about you. What it looks like, the quality of construction, how well it functions – is a direct reflection of you. So why waste your time designing, constructing and maintaining a building that will only look good today? In 10 years, or even 2 years, will your building look as new as the day it opened? Will your building continue to be a positive reflection of you?

Protecting your design, your buildings, your spaces, is how we began. And protecting your reputation, through our obsessive service, is the reason we're still here. In 1979 we began our obsessive commitment to protect buildings and the people who use them, and we haven't stopped. Since then, we've expanded the protection products we manufacture and opened global offices to bring protection to every space, in every building, everywhere.

Your building will stand for you as much now as it will in the years to come. Make sure it stays looking like you intended on the day it opened by protecting it.

The Inpro[®] advantage



Global experience

Inpro[®] has been supplying products throughout the world for over 35 years. We have the expertise to make sure your project conforms to local codes and standards.



Superior service

With our extreme focus on customer service you can rest assured that your project will run smoothly.



Variety of options

Between our colour palettes and product models, we have exactly what you're looking for in your building.

Contents

PVC-u

- 4 The Benefits of PVC-u

Handrails

- 6 Introduction
- 7 Anatomy of Handrails
- 8 800, 900SSR, 910, 920
- 9 940, 1000, 2000, 3110
- 10 3130, 3510, 3530, 3400
- 11 The Christie Centre

Wall Guards

- 12 Introduction
- 13 Anatomy of Wall Guards
Extruded Rubrail, 2500 Chair Rail
- 14 Infinity Bracket, 700, 1400, 1500
- 15 1600, 1800, 1300, 50SS Stainless Steel Wall Guard
- 16 High Impact Wall Base, NuTree[®] Wall Guard
- 17 The Tower Hotel

Corner Guards

- 18 Introduction
- 19 Corner Guard No Tape
- 20 Aluminium Corner Guard, Clear Polycarbonate, NuTree[®] Corner Guard
- 21 130, 150, 160
- 22 130F, 150F, 160F
- 23 Queen Elizabeth Hospital

Wall Protection

- 24 Introduction
- 25 Sanparrel[™] Sheet, Trim Options
- 26 Stainless Steel Wall Panels, NuTree[®] Diamond Plate Sheet
- 27 Tools and Accessories

Door Protection

- 28 Introduction
- 29 Custom Door Frame Guard, 1700 Door Frame Guard, Door Edge Protectors
- 30 Door Face Protection, PVC-u, SS, 10, 20, 30

Reference

- 31 Colours
- Standard Solid
- Woodland
- Elements
- 32 Oakfield High School
- 33 Product Characteristics
- 34 Product Part Index



The Benefits of PVC-u

Safe, durable and recyclable.

At Inpro®, much of our wall protection range utilises PVC-u to provide the most durable and impact resistant products for your building needs. Unmatched protection, wide array of colours and finishes and unique product design are just a few of the reasons that Inpro® chooses to use PVC-u in our products.



1

Safe and trusted

PVC-u is a safe material that is versatile in form and design. It is an inert, non-toxic polymer that is one of the few materials trusted for the storage of live blood cells in products like blood bags and tubing. The medical field also uses it for dry dosage blister packs and IV containers.

Due to the high chlorine content, PVC-u is flame retardant and will self-extinguish when removed from fire.

Multiple studies have concluded that PVC-u is eco-efficient when managed responsibly and provides many sustainable benefits.

2

Durable and diverse

The material is easily processed and formed into a wide variety of products. PVC-u is durable and light-weight making it ideal for installation projects such as cabling, piping, window frames, cladding, fascia boards and even flooring.

PVC-u has a high strength to weight ratio that doesn't corrode and is extremely durable, making it valuable to many industries.

3

Recyclable

PVC-u is perfect for recycling and has the longest history of recycling amongst plastics without losing any of its performance characteristics. This material can be recycled up to seven times over a 200 year life span as a thermoplastic is melted down and converted into new products.

Inpro® PVC-u components contain up to 100% recycled content and all surplus material is granulated and repurposed into other materials.

4

Energy consumption

PVC-u consumes less non-renewable energy resources, such as gas and oil, than all other commodity plastics.

5

Carbon emissions

PVC-u has a relatively low carbon footprint compared to other thermoplastics. For example, it is equivalent in weight to 1kg of frosted cornflakes at 1.9kg CO₂.

Recycled PVC has an even lower carbon footprint with the production of 1kg resulting in the equivalent of 0.3kg CO₂. Some other examples are: 1kg Lamb at 14kg CO₂ and 1kg Cheese at 11kg CO₂.

6

Life cycle assessments (LCAs)

A major revision of the BRE Green Guide was undertaken in 2008 which led to a wide range of PVC-u products being awarded A or A+ ratings, over and above traditional materials.

About 60% of all PVC-u manufactured has a service life between 15-100 years making it a long term solution for many projects.

7

Raw materials

Inpro® uses PVC-u compounds that have a low environmental footprint and meet the European Chemical Regulations known as REACH (Registration, Evaluation, Authorisation and restriction of Chemicals) EC1907-2006.

All raw materials used in the manufacture of Inpro® wall protection are responsibly sourced from suppliers who are or will be ISO 14001 accredited.

Handrails

Safeguard people from slips, falls and more.

Protect your interior walls from damage, and safeguard the people who rely on your buildings from slips, falls and even odor-causing bacteria with our variety of handrails. Whether you're looking for maximum wall protection or code compliance, we have a handrail option for you.

Many of our handrails are designed to meet guidelines BS8300:2009 + A1:2010.



Anatomy of handrails



Aluminium retainer

Aluminium retainer and splice provides structural stability and allows extended lengths over 3.66m.



Mounting bracket

Mounting bracket keeps hands a safe distance from the wall.



Cover

Covers are available in a variety of colours to coordinate with other interior finishes.



Inside/outside corners

Inside/outside corners provide a smooth transition for corner applications.



Returns finish

Returns finish gives the handrail installation a professional look.



Add a reveal

Add a reveal as a decorative element, standard with every Woodland Handrail order.



800 Handrail



Materials

- PVC-u

Colours

- Standard solid colours
- Woodlands

- Ligature-resistant bracket and 50mm standoffs available upon request.



940 Handrail



Materials

- PVC-u

Colours

- Standard solid colours
- Woodlands

- 50mm standoffs standard.



900SSR Round Handrail



Materials

- Type 304 Stainless Steel

Colours

- #4 Brushed Finish

- 50mm standoffs available upon request.



1000 Handrail



Materials

- PVC-u

Colours

- Standard solid colours
- Woodlands

- Ligature-resistant bracket and 50mm standoffs available upon request.



910 Handrail



Materials

- PVC-u

Colours

- Standard solid colours
- Woodlands

- 50mm standoffs available upon request.



2000 Handrail



Materials

- PVC-u

Colours

- Standard solid colours
- Woodlands



920 Handrail



Materials

- PVC-u

Colours

- Standard solid colours
- Woodlands

- 50mm standoffs available upon request.



3110 Round Handrail



Materials

- PVC-u

Colours

- Standard solid colours
- Woodlands

- Ligature-resistant bracket and 50mm standoffs available upon request.



3130 Oval Handrail



Materials

- PVC-u

Colours

- Standard solid colours
- Woodlands

- Ligature-resistant bracket and 50mm standoffs available upon request.



3510 Handrail



Materials

- V- Vinyl

Options

- FV - Woodlands
- S - Stainless Steel
- M - Metal Tone

- 50mm standoffs available upon request.

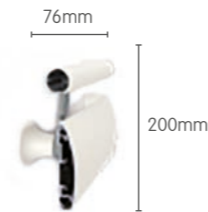

3530 Handrail



Materials

- PVC-u

Colours

- Standard solid colours
- Woodlands

- 50mm standoffs available upon request.



3400 Handrail



Materials

- PVC-u

Colours

- Standard solid colours
- Woodlands

- 50mm standoffs available upon request.

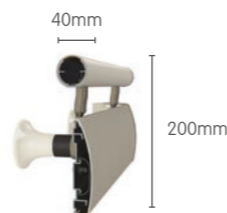

The Christie Manchester, UK

A wide range of Inpro® products have been installed at the new £35 million Patient Treatment Centre at The Christie in Manchester, helping to create a hygienic, safe and stylish environment for patients and visitors.

Wall guards, bedhead protectors and corner guards were installed throughout the corridors and treatment areas.

Product Specified:

- 700i Wall Guards
- Standard Corner Guards

Inpro® wall protection systems prevent the build-up of dirt and other grime in damaged surfaces which reduces the need for ongoing repair and maintenance. This saves time and money and improves the long-term appearance of the building.



Wall Guards

Prevent scratches and dents.

Guard your walls from scratches, dents and scrapes by installing one of our Wall Guards. There's no need to let wheelchairs, hospital beds and service carts leave you with constant maintenance. Our Wall Guards add a decorative element while providing a continuous and highly durable impact bumper that keeps your walls free from damage.



Anatomy of wall guards

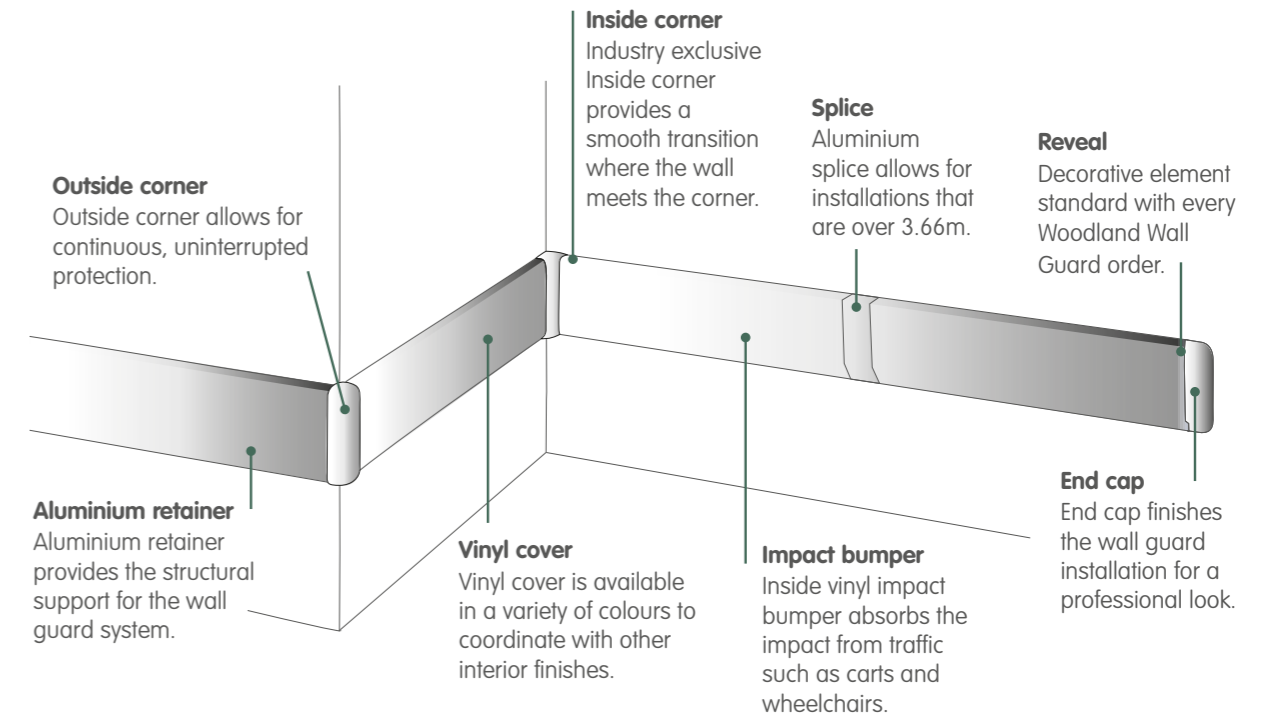

Extruded Rubrail

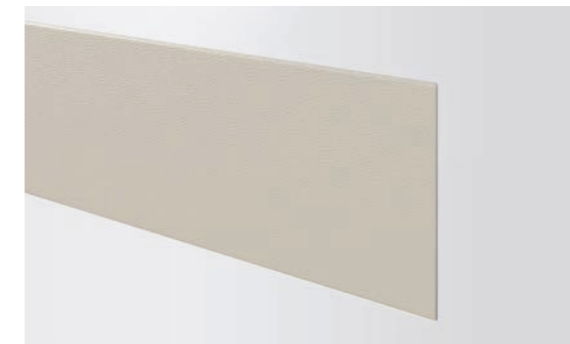

- Materials**
- PVC-u with and without tape
- Colours**
- Standard solid colours
 - RR150 and RR200 Extruded Rubrail offer the same protection levels as Sanparrel™ Sheet.

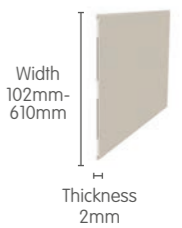

2500 Chair Rail



- Materials**
- PVC-u
- Colours**
- Standard solid colours
 - Woodlands



Infinity Bracket

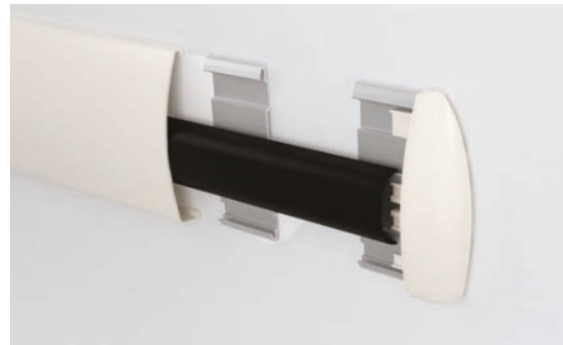

The Infinity Bracket is a shortened Aluminium retainer that reduces the cost of having a full retainer. It's also easier to install in short runs.

Features and benefits

- Reduces cost
- Easy to install
- Reduces material waste
- Continuous retainer

● Available on the 700, 1400, 1500, 1600, 1800 wall guards.

700 Wall Guard



Materials

- PVC-u

Colours

- Standard solid colours
- Woodlands

Retainer Choices

- Continuous Bracket
- Infinity Bracket



1400 Wall Guard

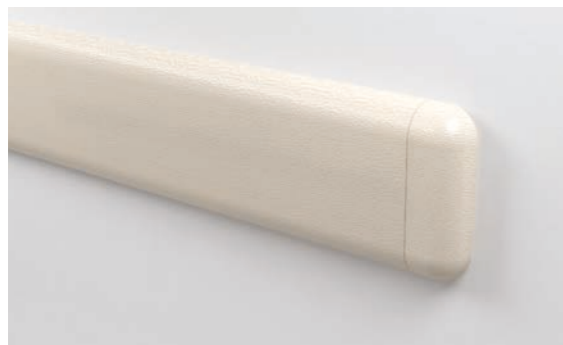

Materials

- PVC-u

Colours

- Standard solid colours
- Woodlands

Retainer Choices

- Continuous Bracket
- Infinity Bracket



1500 Silhouette Wall Guard



Materials

- PVC-u

Colours

- Standard solid colours
- Woodlands

Retainer Choices

- Continuous Bracket
- Infinity Bracket

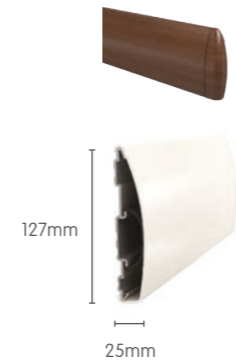

1600 Wall Guard



Materials

- PVC-u

Colours

- Standard solid colours
- Woodlands

Retainer Choices

- Continuous Bracket
- Infinity Bracket



1800 Wall Guard



Materials

- PVC-u

Colours

- Standard solid colours
- Woodlands

Retainer Choices

- Continuous Bracket
- Infinity Bracket

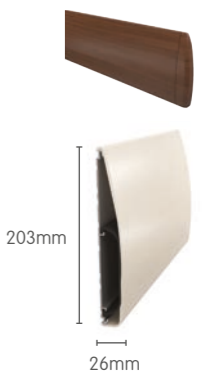

1300 Wall Guard



Materials

- PVC-u

Colours

- Standard solid colours



50SS Stainless Steel Wall Guard



Materials

- Stainless Steel Type 304

♻️ Contains up to 75% post-consumer recycled material.

- Widths ranging up to 152mm available, visit inprocorp.com for more information.

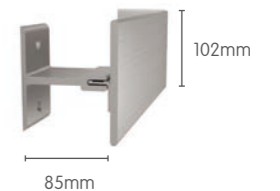

Factory pre-cut sections to field measurements non-returnable.

High Impact Wall Base



Materials
• PVC-u

Colours
• Standard solid colours



NuTree® Wall Guard



Custom sizes and colours available with minimums.
Multiple heights and thicknesses available. Please reference
Part Number Index for more information.

Colours

Black 11	Weather Wood 05
Dove Gray 13	Sandstone 04

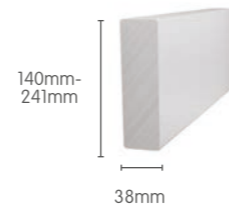

The Tower Hotel London, UK

Standard Corner Guards were installed at The Tower Hotel in London, to help create a clean, attractive and low maintenance environment. The hotel was undergoing a renovation programme to update its 800 guestrooms, bars and restaurants, in preparation for the 2012 Olympics.

Inpro® supplied Standard PVC-u Corner Guards for the hotel's busy corridors to protect the new décor from scuffs, scrapes and stains caused by footwear, luggage, wheelchairs and buggies.

Neutral shades were specified to co-ordinate and harmonise with the hotel's contemporary interior design scheme.

The Hotel Manager wanted to maintain the highend, contemporary interior and keep it looking as good as new.

The PVC-u corner guards help to reduce costly repair and maintenance work, and extend the lifecycle of the hotel.



Corner Guards

Protect the most vulnerable parts of your walls from damage.

Corners are susceptible to endless damage. Protect them and keep your facility looking newer longer with Corner Guards from IPC®. Whether you need a quick fix or an integrated, fire rated solution, we have the right corner guard for you.



Corner Guard, No Tape



Materials

- PVC-u

Colours

- Standard solid colours

Angles

90°

Heights

2.4m



30mm, 50mm
or 75mm

Corner Guards



Aluminium Corner Guard



Angles
90° | 19mm, 38mm wings

Heights
1.2m, 2.4m, 2.7m, 3.6m

- Product to be installed with adhesive.



19mm
or 38mm

130 Corner Guard



Materials
PVC-u

Colours
• Standard solid colours
• Woodlands

Angles
135° | 76mm wing

Heights
1.2m, 2.4m, 3.66m

- Custom bendable aluminium retainer with flexible top caps available.



76mm x 76mm

Clear Polycarbonate Corner Guard



Angles
90° and 135° | 19mm, 29mm, 64mm wings

Heights
1.2m, 2.4m

- Custom sizes available, please call for details.



29mm
or 19mm



64mm

Not provided with pre-drilled holes.

150 Corner Guard



Materials
PVC-u

Colours
• Standard solid colours
• Woodlands

Angles
90° | 76mm wing

Heights
1.2m, 2.4m, 3.66m

- Custom bendable aluminium retainer with flexible top caps available.



76mm x 76mm



76mm x 76mm

NuTree® Corner Guard



Materials
Post-consumer recycled No.2 plastic

Colours
• Black only

Angles
90° | 80mm wing

Heights
2.4m

- Multiple heights and thicknesses available. Please reference Part Number Index for more information.



80mm x 80mm

160 Corner Guard



Materials
PVC-u

Colours
• Standard solid colours
• Woodlands

Angles
90° | 51mm wing

Heights
1.2m, 2.4m, 3.66m

- Custom bendable aluminium retainer with flexible top caps available.



51mm x 51mm



51mm x 51mm

130F Flush Mount



Materials
PVC-u

Colours
• Standard solid colours
• Woodlands

Angles
135° | 76mm wing

Heights
1.2m, 2.4m, 3.66m



76mm x 76mm

150F Flush Mount



Materials
PVC-u

Colours
• Standard solid colours
• Woodlands

Angles
90° | 76mm wing

Heights
1.2m, 2.4m, 3.66m



76mm x 76mm

160F Flush Mount

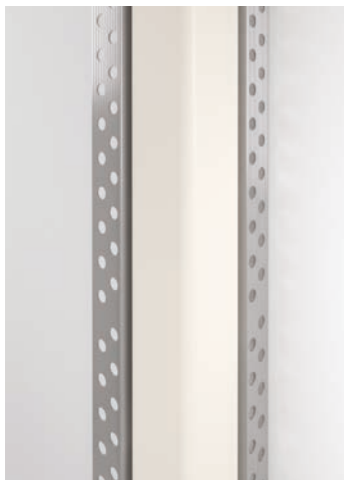

Materials
PVC-u

Colours
• Standard solid colours
• Woodlands

Angles
90° | 51mm wing

Heights
1.2m, 2.4m, 3.66m



51mm x 51mm



Queen Elizabeth University Hospital Glasgow, UK

Queen Elizabeth University Hospital is a brand new 14 floor adult hospital building designed and built to replace four ageing hospitals across Glasgow, some of which date back to Victorian times. Officially opened by Queen Elizabeth in July 2015, the new build hospital is set over 26,000 sq. metres and is one of the biggest critical care complexes in Europe.

The main hospital has a total of 1,109 individual patient bedrooms and is integrated with a 256 bed children's hospital. These hospitals combined together make up the largest single NHS hospital in Scotland. Inpro® has supplied approximately 40,000 linear metres of wall protection within the hospital, which equates to roughly 25 miles (40km) of product.

To meet the needs of the Queen Elizabeth University Hospital a broad range of wall protection products were specified.

A variety of handrails were installed to provide support and guidance for individuals, whilst also providing some protection from impact in areas that experience high volumes of pedestrian and wheeled traffic.

Other products used within the project were high impact corner guards to protect the most vulnerable parts of the building and Sanparrel™ PVC-u sheeting to help reduce and conceal the effects of impact and abrasion.



Wall Protection

Design your walls with added protection.

Whether you're looking to protect your lobby or maintenance room, we have products to accommodate your every need.



Sanparrel™ Sheet

Durable, long lasting and easy to clean.

Sanparrel™ Sheet provides a complete range of protection for your vertical surfaces. It ensures reliable wall protection that is durable, long lasting and easy to clean.

Standard solid colours

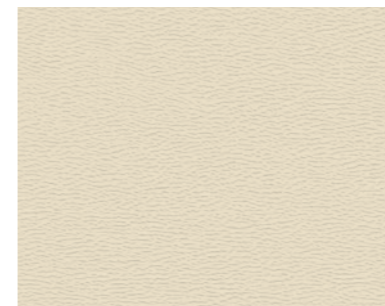

Elements patterns



Woodland



Sanparrel™ Sheet advantages:

- Made from PVC-u.
- Thicknesses: 1mm, 1.5mm and 2mm*.
- Low maintenance velvet texture.
- Variety of trim accessories.

*Custom thickness, minimum requirements apply.

Trim Options

Damaged walls leave a lasting impression on patients and staff. Make sure the walls in your facility are conducive to a healing environment and won't leave your maintenance staff making endless repairs.

Solid coloured trim



Stainless steel trim



Faux metal trim



Aluminium trim



Stainless Steel Wall Panels

Strong protection with a sleek look.

Stainless steel wall panels provide unmatched protection for the walls of your facility. We take the ease of installation to another level with pre-manufactured panels that are ready to go without on-site cutting required. Even more, our panels feature formed edges that provide a flat seam for a smooth, subtle and continuous transition where dirt won't be able to hide.

- 18 gauge type 304 stainless steel #4 brushed finish standard.
- 14, 16 and 20 gauge available.
- Factory fabricated to size.
- Maximum panel size: 1.2m x 3m.
- Type 430 available.
- Formed edge for continuous transitions.
- Available corner trim.



Front view



Back view

NuTree® Durability matters.

NuTree® is a high-impact, heavy-duty solution for those areas in your building that take the toughest abuse. These products are great for back of house or maintenance areas that suffer the endless damage caused by carts, heavy equipment and more.

NuTree® Diamond Plate Sheet

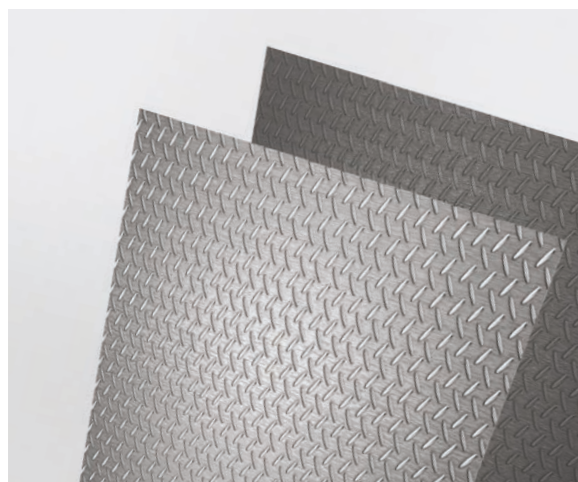

Durable diamond plate design is manufactured from Medium Density Polyethylene (MDPE), providing heavy-duty protection in back-of-house areas and loading docks.

Standard size: 1.2m x 2.4m

- Sheets are easy to cut and mount to the wall with fasteners.



Tools and Adhesives

Inpro® Bond Adhesive



Sizes

- 531 - 4.5ltrs
- 541 - 22.7ltrs

- Adhere Rigid Sheet and Extruded Rubrails firmly to the wall.
- Water-based, trowel-on mastic.
- Allow for repositioning during installation.
- Non-flammable and virtually odourless.
- Mold and mildew resistant does not promote the growth of bacteria.
- Freeze-thaw stable adhesive allows shipping during any time of the year.
- 4.5ltrs will adhere approximately four 1.2m x 2.4m sheets.
- 22.7ltrs will adhere approximately twenty-one, 1.2m x 2.4m sheets.

IPC® Vinylseal



Sizes

- 580 - 28.5ml Cartridge

- Fill seams and joints on Sanparrel™ Sheet and profile products.
- Available in standard colours.

Notched Trowel



545 - Trowel

- Specifically designed to quickly and uniformly spread Inpro® Bond adhesive.
- Custom designed 3mm v-notch increases adhesive coverage.

Extension Roller



333 - Extension Roller

- Aids in the installation of Vinyl Sheet, Door Face Protection and Extruded Rubrails.
- Features a telescoping handle, triple roller and raised grip.

Vinyl Removal Tool



340 - Vinyl Removal Tool

- Designed with an offset, smooth blade for safe and easy removal of vinyl covers for replacement or maintenance.
- Non-slip textured vinyl grip for comfort and control.
- Can be used on all vinyl covers for handrails, wall guards, chair rails and corner guards.

Door Protection

Protection for all areas of your doorway.

Doors, door frames and door accessories are necessities in buildings. They can also take a great deal of mistreatment. IPC® Door Protection products are made with our PVC-u material so they are sure to withstand incessant abuse. From Door Frame Protection to Door Face Protection, our products will help keep your door areas pristine.



Custom Door Frame Guards



Materials

- PVC-u

Colours

- Standard solid colours
- Woodlands

Standard Heights
915mm, 1.2m, 2.4m

- Install with contact cement.

Door Edge Protectors are custom products and are not returnable.

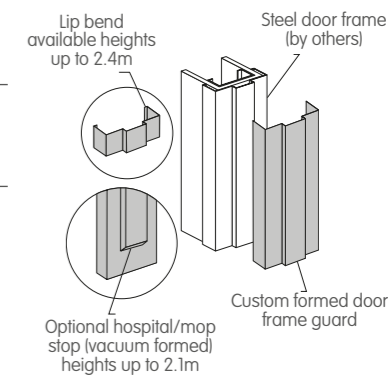

1700 Door Frame Guards



Materials

- PVC-u

Colours

- Standard solid colours
- Woodlands

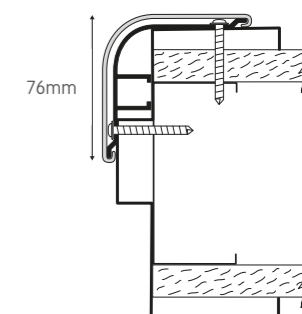

Door Edge Protector



Materials

- PVC-u

Colours

- Standard solid colours
- Woodlands

Standard Heights
915mm, 1.2m, 2.4m

- Install with contact cement.

Door Edge Protectors are custom products and are not returnable.

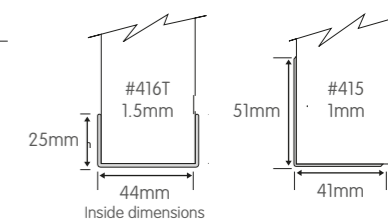

Door Face Protectors

Don't let heavy traffic lead to damage.

Doors are relentlessly pushed, banged and kicked open. Keep your doors and their surrounding environments in pristine condition.

PVC-u Door Face Protector



Materials
PVC-u

Colours

- Standard solid colours
- Elements
- Woodlands

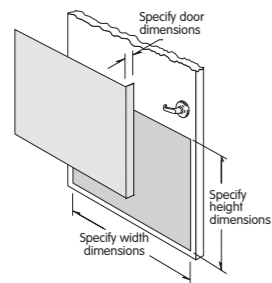

Stainless Steel Door Face Protector



Materials

Stainless Steel Door Face Protection offers a #4 satin finish.

- Conforms to NSF Standard 51 for direct food contact in food service areas (Type 304 Stainless Steel).

- Type 430 or 304
- 14, 16 or 18 gauge

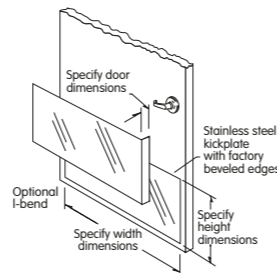

Door Face Protection are custom products and are not returnable.

Designer Model 10

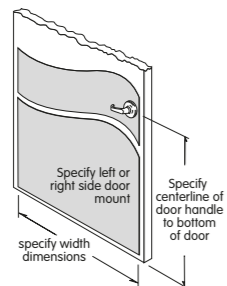

Materials
• PVC-u

Colours

- Standard solid colours
- Elements
- Woodlands

Designer Model 20

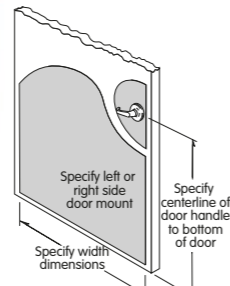

Materials
• PVC-u

Colours

- Standard solid colours
- Elements
- Woodlands

Designer Model 30

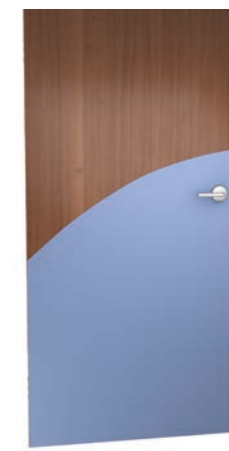

Materials
• PVC-u

Colours

- Standard solid colours
- Elements
- Woodlands

Colour Guide

Standard solid colours

 LRV 78.7 Designer White 0101	 LRV 77.0 White Sand 0103	 LRV 71.1 Clam Shell 0154	 LRV 68.4 Eggshell 0111	 LRV 43.4 Burlap 0252	 LRV 70.5 Light Beige 0109
 LRV 56.9 Beeswax 0249	 LRV 77.77 Canary 1050	 LRV 69.84 Sunny Day 1051	 LRV 34.21 Honey 1053	 LRV 51.3 Sherbet 1052	 LRV 36.69 Mandarin 1054
 LRV 9.6 Truffle 0284	 LRV 7.7 Cabernet 0241	 LRV 11.2 Cardinal 0236	 LRV 55.21 Mint 1056	 LRV 59.33 Aloe 1057	 LRV 19.82 Clover 1058
 LRV 34.8 Crystal Jade 0187	 LRV 16.6 English Green 0125	 LRV 49.09 Cloudy 1059	 LRV 25.5 Buoyant Blue 0132	 LRV 19.5 Periwinkle 0272	 LRV 8.9 Point Blue 0165
 LRV 15.8 Purple Haze 0171	 LRV 17.36 Orchid 1055	 LRV 52.0 Taupe 0113	 LRV 22.4 River Rock 0351	 LRV 48.1 Silver 0105	 LRV 37.1 Dove Gray 0106
 LRV 17.5 Pewter Gray 0107	 LRV 42.2 Sharkskin 0350	 LRV 10.8 Castle 0256	 LRV 4.5 Black 0152		

Woodland patterns

Woodlands offer a wood grain appearance without the maintenance of traditional wood.

 LRV 57.7 Natural Maple 0531	 LRV 30.5 Applewood 0537	 LRV 15.9 Honeynut 0535	 LRV 9.2 Boston Cherry 0534	 LRV 37.3 Santa Rosa 0532	 LRV 6.3 American Walnut 0555
---	---------------------------------------	--------------------------------------	--	--	--

Elements patterns

 LRV 37.1 Brushed Silver 5E025	 LRV 17.5 Brushed Nickel 5E026
---	---

Due to the printing process, colours may vary. For accurate colour selection, please request samples. Visit inprocorp.com for more information.



Oakfield High School Wigan, UK

Inpro® supplied Oakfield High School in Wigan with Sanparrel and Rubrails from the Door + Wall range to add to the school's cutting edge design.

Sanparrel™ Rigid Sheet was installed to provide total protection as well as providing an appropriate contrast with the sports floor. Rubrails were used to protect areas exposed to impact and abrasion.

Used in conjunction with the rubrails, stainless steel corner guards were fitted throughout the school to protect the most vulnerable areas of the walls. Stainless steel is also hygienic, corrosion resistant and easy to clean, helping to reduce maintenance costs.

All products specified meet guidelines BS8300:2009+A1:2010.

Product Specified:

- Rubrails
- Sanparrel™ Rigid Sheet
- Stainless Steel Corner Guards



IPC® Product Characteristics



Fire Performance:

Tested in accordance with EN ISO 11925-2:2010 and EN 13823:2010+A1:2014 and classified according to EN 13501-1:2007+A1:2009 as - Reaction to fire classification: B – s3, d0.



Chemical Resistance:

Tested in accordance with BS EN ISO 175:2010. BS2782-8: Method 830A:1999. Plastics – Methods of test for the determination of the effects of immersion in liquid chemicals. The results show that the products as tested are resistant to most commonly used chemical solutions.



Bacterial Resistance:

Tested in accordance with BS EN ISO 846:1997. Plastics – Evaluation of the action of microorganisms. The results show that the products as tested did not support bacterial growth.



Fungal Resistance:

Tested in accordance with BS EN ISO 846:1997. Plastics – Evaluation of the action of microorganisms. The results show that the products as tested did not support fungal growth.



VOC Emissions:

Tested in accordance with BS EN ISO 16000-9:2006. Indoor air – Part 9: Determination of the emission of volatile organic compounds from building products and furnishing – Emission test chamber method. The results show that the products as tested meet low emissions requirements.



RIBA:

Inpro® is a proud network member of the Royal Institute of British Architects (RIBA). We are able to provide informational resources that help you stay current on architectural trends and practices. RIBA champions better buildings, communities and the environment through architecture and we want to help you do the same. Through our membership, we provide the standards, training, support and recognition to help you excel in your profession.

Visit inprocorp.com for more information about RIBA certified presentations and CPD courses.

Product Part Index

Handrails

800 HANDRAIL

800 - 140mm Height with cover and Aluminium retainer
1001 - Mounting Bracket
802 - Return
803 - Outside Corner
803135 - 135° Outside Corner
804 - Splice
805 - Inside Corner
805135 - 135° Inside Corner
CBRKLF - + Continuous Mounting Bracket
NOTE: Add suffix "W" to part number for Woodland finish.

900 ROUND STAINLESS STEEL HANDRAIL

900SSR-FT - 38mm Round SS HR
909SS-SDL - SS Mounting Bracket
902SSR-RET - 38mm round return pre-assembled
903SSR-COR - 178mmx178mmx38mm round corner 90°
903135SSR-COR - 178mmx178mmx38mm round corner 135°
906SSR-SPL - Splice

910 ROUND HANDRAIL

910 - 38mm Round Grip w/ 2mm cover
908 - Vinyl Mounting Bracket
909SS - SS Mounting Bracket
912 - Vinyl Left Return
912SS - Stainless Steel Left/Right Return
913 - Vinyl Right Return
914 - Vinyl Outside Corner 90°
914135 - Vinyl Outside Corner 135°
914SS - Stainless Steel Inside/outside Corner
915 - Vinyl Inside Corner
NOTE: Add suffix "W" to part number for Woodland finish.

920 OVAL HANDRAIL

920 - 38mm Oval Grip w/ 2mm cover
908 - Vinyl Mounting Bracket
909SS - SS Mounting Bracket
922 - Vinyl Left Return
922SS - Stainless Steel Left/Right Return
923 - Vinyl Right Return
924 - Vinyl Outside Corner 90°
924135 - Vinyl Outside Corner 135°
924SS - Stainless Steel Inside/outside Corner
925 - Vinyl Inside Corner
NOTE: Add suffix "W" to part number for Woodland finish.

940 HANDRAIL

940 - 40mm Round Grip w/ 2mm cover
941 - Aluminium Mounting Bracket
942 - Left/Right Return
944 - Vinyl Inside/Outside Corner (UK only)
941UK - Stainless Steel Mounting Bracket
NOTE: Add suffix "W" to part number for Woodland finish.

1000 HANDRAIL

1000 - 110mm Handrail 12'
1002 - 110mm Left Return
1003 - 110mm Right Return
1004 - 110mm Outside Corner 90°
1004135 - 110mm Outside Corner 135°
1005 - 110mm Inside Corner 90°
1005135 - 110mm Inside Corner 135°
1001 - Handrail Mounting Bracket
804 - Splice
CBRKLF - Continuous Mounting Bracket
NOTE: Add suffix "W" to part number for Woodland finish.

2000 HANDRAIL

2000 - 32mmx57mm Grip with 2mm Cover
2001 - Mounting Bracket
2001SS - Stainless Steel Mounting Bracket

2002 - Left Return
2003 - Right Return
2004 - Inside/Outside Corner
2004135 - 135° Inside/Outside Corner
906 - Splice

3110 ROUND HANDRAIL

3110 - 155mm H w/ Round Grip
1001 - Mounting Bracket
3112 - Left Return
3113 - Right Return
3114 - Outside Corner 90°
3114135 - Outside Corner 135°
3115 - Inside Corner 90°
3115135 - Inside Corner 135°
NOTE: Add suffix "W" to part number for Woodland finish.

3130 OVAL HANDRAIL

3130 - 155mm H w/ Oval Grip
1001 - Mounting Bracket
3132 - Left Return
3133 - Right Return
3134 - Outside Corner 90°
3134135 - Outside Corner 135°
3135 - Inside Corner 90°
3135135 - Inside Corner 135°
NOTE: Add suffix "W" to part number for Woodland finish.

3510 ROUND HANDRAIL

3510 - 200mm H w/ Round Grip
3516 - Aluminium Splice Assembly
3511 - Mounting Bracket
3512 - Left Return
3513 - Right Return
3514 - Outside Corner 90°
3514135 - Outside Corner 135°
3515 - Inside Corner 90°
3515135 - Inside Corner 135°

3530 OVAL HANDRAIL

3530 - 200mm H w/ Oval Grip
3516 - Aluminium Splice Assembly
3511 - Mounting Bracket
3532 - Left Return
3533 - Right Return
3534 - Outside Corner 90°
3534135 - Outside Corner 135°
3535 - Inside Corner 90°
3535135 - Inside Corner 135°

3400 HANDRAIL

3400 - 200mm H w/ 40mm Round Grip
3501 - Mounting Bracket
3401UK - Mounting Bracket (for UK only)
3402 - Left Return
3403 - Right Return
3404 - Outside Corner 90°
3405 - Inside Corner 90°

Wall Guards

EXTRUDED RUBRAIL

RR150 - 2mmx150mmx3.66m tape-on
RR150N - 2mmx150mmx3.66m adhesive mount
RR200 - 2mmx200mmx3.66m tape-on
RR200N - 2mmx200mmx3.66m adhesive mount

2500 CHAIR RAIL

51mm high
2500 - 1.8mm cover and 1.5mm continuous Aluminium retainer, 3.66m length
2501 - End Cap

2502 - Outside Corner
2503 - Inside Corner
2504 - Picture Frame Corner (Standard Solid Colors Only)
NOTE: Add suffix "W" to part number for Woodland.

700 WALL GUARD

197mm high
700 - Cover and Aluminium retainer, 3.66m length
701 - End Cap
702 - Outside Corner
707 - Inside Corner (Not available in woodland pattern)
706A - Optional Aluminium Splice
801 - Optional Mounting Bracket
1601 - Optional 12mm thick x 50mm diameter Rubber Spacer. Add suffix "W" to part number for Woodland.
Add suffix "I" for infinity bracket.

1400 WALL GUARD

102mm high
1400 - Cover and Aluminium retainer supports, 12' length
1402 - End Cap
1403 - Outside Corner
1407 - Inside Corner
501 - Optional 12mm thick x 50mm dia. Rubber Spacer
* 1400 is a custom product. Minimums apply and product is not returnable. Add suffix "W" to part number for Woodland. Add suffix "I" for infinity bracket.

1500 SILHOUETTE WALL GUARD

127mm high
1500 - Cover and Aluminium retainer, 3.66m length
1501L - Left End Cap
1501R - Right End Cap
1502 - Outside Corner
1503 - Inside Corner
1601 - Optional 12mm thick x 50mm Oval Rubber Spacer. Add suffix "W" to part number for Woodland. Add suffix "I" for infinity bracket.

1800 WALL GUARD

203mm high
1800 - 203mm High Wall Guard with cover and Aluminium retainer, 3.66m length
1601 - Optional 12mm thick x 100mm Oval Rubber Spacer
1801L - Left End Cap
1801R - Right End Cap
1802 - Outside Corner
1803 - Inside Corner
706A - Optional Aluminium Splice
Add suffix "I" for infinity bracket. Add suffix "W" for woodlands.

1300 WALL GUARD

103mm high
1300 - Cover and Aluminium retainer, 3.66m length
1302 - End Cap
1303 - Outside Corner
1307 - Inside Corner
501 - Optional 12mm thick x 50mm dia. Rubber Spacer

1600 WALL GUARD

152mm high
1600 - Cover and Aluminium retainer, 3.66m length
1622 - End Cap
1623 - Outside Corner
1627 - Inside Corner
1606A - Optional Aluminium Splice
801 - Optional Mounting Bracket
1601 - Optional 12mm thick x 50mm dia. Rubber Spacer
Add suffix "I" for infinity bracket.

50SS STAINLESS STEEL WALL GUARD

102mm high
50SS - 100mm High Stainless Steel Wall Guard, pre-assembled
50SSLR - Stainless Steel Left Return
50SSRR - Stainless Steel Right Return
50SSOC - Stainless Steel Outside Corner
50SSIC - Stainless Steel Inside Corner
50AABK - Aluminium Bracket
Contains up to 75% post-consumer recycled material.
Factory pre-cut sections to field measurements non-returnable.

HIGH IMPACT WALL BASE

102mm high
WB4 - 10mm thick x 100mm high
WB4LEC - Left End Cap
WB4REC - Right End Cap
WB4OC - Outside Corner
WB4IC - Inside Corner
Lead time may vary.

NUTREE® WALL GUARD

140mm-241mm high
NT- 140, 12mm Thick x 203mm High x 3.66m Long
NT - 518, 25mm Thick x 140mm High x 3.66m Long
NT - 690, 38mm Thick x 140mm High x 3.66m Long
NT - 694, 38mm Thick x 190mm High x 3.66m Long
NT - 695, 38mm Thick x 241mm High x 3.66m Long
Lead times may vary. Custom sizes and colors available with minimums.

Corner Guards

CORNER GUARD (NO-TAPE)

30 CGN - 30mmx30mmx2.4m, 90°
50 CGN - 50mmx50mmx2.4m, 90°
75 CGN - 75mmx75mmx2.4m, 90°
NOTE: Add suffix "W" for Woodland.

ALUMINIUM

90° | 19mm, 38mm wings
DW-ALUM-3448 - 19mm x 19mm x 1.2m,90°
DW-ALUM-3496 - 19mm x 19mm x 2.4m,90°
DW-ALUM-11248 - 38mm x 38mm x 1.2m,90°
DW-ALUM-11296 - 38mm x 38mm x 2.4m,90°
Custom sizes available.

CLEAR POLYCARBONATE CORNER GUARDS

90° and 135° | 19mm, 29mm, 64mm wings
434* - 19mm x 19mm x 1.2m, 90°
834* - 19mm x 19mm x 2.4m, 90°
4118 - 29mm x 29mm x 1.2m, 90°
8118 - 29mm x 29mm x 2.4m, 90°
421290 - 64mm x 64mm x 1.2m, 90°
821290 - 64mm x 64mm x 2.4m, 90°
4212135 - 64mm x 64mm x 1.2m, 135°
8212135 - 64mm x 64mm x 2.4m, 135°
Custom sizes available, please call for details. *Not provided with pre-drilled holes.

NUTREE® CORNER GUARD

90° | 80mm Wing-black
NT-CG11 - 80mm x 80mm x 2.4m

130 CORNER GUARDS

135° | 76mm wing
134 - 76mm x 76mm x 1.2m, 135°
138 - 76mm x 76mm x 2.4m, 135°
139 - 76mm x 76mm x 2.74m, 135°
1312 - 76mm x 76mm x 3.66m, 135°

Note: Add suffix "W" for Woodland. Retainer. Custom bendable Aluminium retainer with flexible top caps available. US Patent 8,828,522.

130F FLUSH MOUNT CORNER GUARD

135° | 76mm wing
134F - 76mm x 76mm x 1.2m, 135°
138F - 76mm x 76mm x 2.4m, 135°
139F - 76mm x 76mm x 2.74m, 135°
1312F - 76mm x 76mm x 3.66m, 135°

130B-4 - 1.2m Cove Base Retainer
130B-6 - 1.8m Cove Base Retainer
130F-Cap - Closure Cap

150 CORNER GUARDS

90° | 76mm wing
154 - 76mm x 76mm x 1.2m, 90°
158 - 76mm x 76mm x 2.4m, 90°
159 - 76mm x 76mm x 2.74m, 90°
1512 - 76mm x 76mm x 3.66m, 90°
Note: Add suffix "BN" for BluNose® PVC-u Retainer. Add suffix "W" for Woodland. Custom bendable Aluminium retainer with flexible top caps available. US Patent 8,828,522.

150F FLUSH MOUNT CORNER GUARD

90° | 76mm wing
154F - 76mm x 76mm x 1.2m, 90°
158F - 76mm x 76mm x 2.4m, 90°
159 - 76mm x 76mm x 2.74m, 90°
159F - 76mm x 76mm x 2.74m, 90°
1512F - 76mm x 76mm x 3.66m, 90°
150B-4 - 1.2m Cove Base Retainer
150B-6 - 1.8m Cove Base Retainer
150F-Cap - Closure Cap

160 CORNER GUARDS

90° | 51mm wing
164 - 51mm x 51mm x 1.2m, 90°
168 - 51mm x 51mm x 2.4m, 90°
169 - 51mm x 51mm x 2.74m, 90°
1612 - 51mm x 51mm x 3.66m, 90°
Note: Add suffix "W" for Woodland. Custom bendable Aluminium retainer with flexible top caps available. US Patent 8,828,522.

160F FLUSH MOUNT CORNER GUARD

90° | 51mm wing
164F - 51mm x 51mm x 1.2m, 90°
168F - 51mm x 51mm x 2.4m, 90°
169F - 51mm x 51mm x 2.74m, 90°
1612F - 51mm x 51mm x 3.66m, 90°
160B-4 - 1.2m Cove Base Retainer
160B-6 - 1.8m Cove Base Retainer
160F-Cap - Closure Cap

Wall Protection

SANPARREL™ SHEET - SOLID COLORS

405 - 1mm Thick, 1.2m x 2.4m (Standard size)
406 - 1.5mm Thick, 1.2m x 2.4m (Standard size)
Visit inprocorp.com/ipc for specific size and thickness information.

SANPARREL™ SHEET - ELEMENT PATTERNS

405E - 1mm Thick, 1.2m x 2.4m (Standard size)
406E - 1.5mm Thick, 1.2m x 2.4m (Standard size)

SANPARREL™ SHEET - WOODLAND PATTERNS

405W - 1mm Thick, 1.2m x 2.4m (Standard size)
406W - 1.5mm Thick, 1.2m x 2.4m (Standard size)

SOLID COLORED TRIM

Available in PVC-u
407-Top Cap, 2.4m length
408-Vertical Divider Bar, 2.4m length
409-Inside Corner, 2.4m length
* 3m Trim Available

STAINLESS STEEL TRIM

DW-SSTC08 Top Cap, 2.4m length
DW-SSDB08 Vertical Divider Bar, 2.4m length
* 3m Trim Available

FAUX METAL TRIM

in Bright Silver PVC-u Only
407M-0369 Top Cap, 2.4m length
408M-0369 Vertical Divider Bar, 2.4m length
409M-0369 Inside Corner, 2.4m length
* 3m Trim Available

ALUMINIUM TRIM

in Clear Anodized Satin Finish
407A-CL Top Cap, 2.4m length
408A-CL Vertical Divider Bar, 2.4m length
409A-CL Inside Corner, 2.4m length
420A-CL Outside Corner, 2.4m length
421A-CL Outside Corner, 3m length

NUTREE® DIAMOND PLATE SHEET

NT-DP4896-BLK - 4.7mm thick, 1.2m x 2.4m
NT-DP4896-GRY - 4.7mm thick, 1.2m x 2.4m

Door Protection

1700 DOOR FRAME GUARD

1736 - 76mm x 76mm x .9m with 2mm cover and 2mm Aluminium retainer
1748 - 76mm x 76mm x 1.2m with 2mm cover and 2mm Aluminium retainer
1796 - 76mm x 76mm x 2.4m with 2mm cover and 2mm Aluminium retainer

CUSTOM DOOR FRAME GUARDS

Available in 1mm thickness
400C - .9m Height, up to 292mm Width
399C - .9m Height, over 292mm Width
398C - 1.2m Height, up to 292mm Width
397C - 1.2m Height, over 292mm Width
396C - 2.4m Height, over 292mm Width
395C - 2.4m Height, up to 292mm Width
Hospital mop stop frames are available. Custom Formed Door Frame Guards are custom products and are not returnable. Designed for metal frames only.

DOOR EDGE PROTECTOR

Available in 1mm thickness - PVC-u
415 - .9m Height, Long-shape, with factory applied adhesive
415N - .9m Height, Long-shape, without adhesive
41596 - 2.4m Height, Long-shape, with factory applied adhesive
41596N - 2.4m Height, Long-shape, without adhesive
416TC - .9m Height, textured U-shape, cement-on
416TS - .9m Height, textured U-shape, screw-on
41696TC - 2.4m Height, textured U-shape, cement-on
41696TS - 2.4m Height, textured U-shape, screw-on
Door Edge Protectors are custom products and are not returnable.

PVC-U DOOR FACE PROTECTION

SPECIFY YOUR HEIGHT AND WIDTH.

K4 - .1mm Thick
K6 - 1.5mm Thick
K8* - 2mm Thick
*2mm thick. Minimum order requirements may apply.
Door Face Protectors are a custom product and are not returnable.

STAINLESS STEEL DOOR FACE PROTECTION

Stainless Steel Door Face Protection offers a #4 satin finish
SS-KP - Type 430 or 304, 16 Gauge
SS-KP - Type 430 or 304, 16 Gauge w/Long-Bend
Cement-on or screw-on options available. 14 & 18 gauge alloys are also available. Stainless Steel Door Face Protectors are custom products. Products are not returnable. Custom shapes available.

DESIGNER DOOR FACE PROTECTION

K41 - 1mm Thick - Model 10
K61 - 1.5mm Thick - Model 10
K42 - 1mm Thick - Model 20
K43 - 1mm Thick - Model 30
K62 - 1.5mm Thick - Model 20
K63 - 1.5mm Thick - Model 30
Designer Door Face Protectors are custom products. Set-up charges apply and products are not returnable.